

Article number: 07148400001

Description: Universal joint single 0.148.400.001
S=130 X= Bore with keyway

Measures

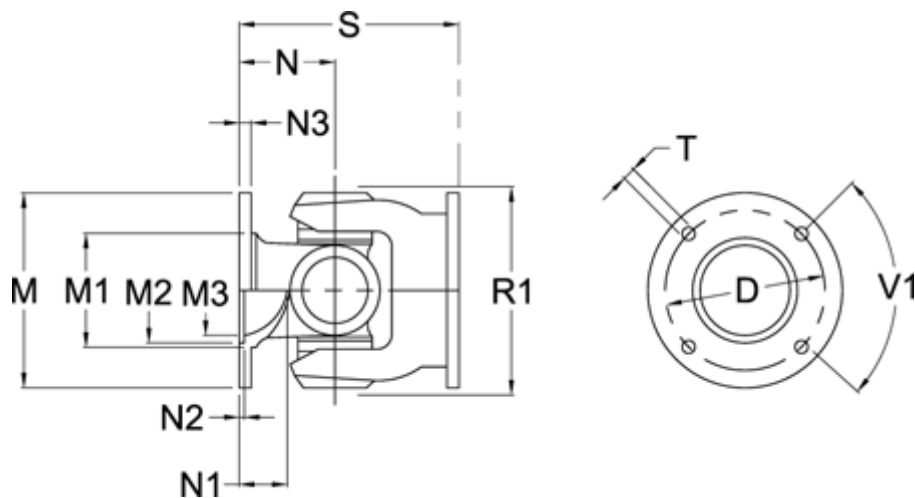

D	= 130 +0,1	N2	= 3 +0,5
Flange diameter M	= 150	N3	= 10
M1	= 104	Number og Flangeholes	= 8
M2	= 90	R1	= 138
M3	= 76	S min	= 130
Max. Bending Angle degrees	= 20	T	= 12 B12
N	= 65	V1 degrees	= 45
N1	= 32		